

## Motion sensing with optical interrupters—selecting the proper sensor for optimum system design.

This application bulletin will discuss many of the variables associated with single channel encoding. This will include design considerations for using both non-apertured and apertured transistors or Photologic™ output devices. Refer to application bulletins 203 and 206 for additional information.

### General Discussion

The most common application of optoelectronics is the sensing of motion with an optical interrupter. The normal single channel optical interrupter module consists of an emitter or energy source and a receiver or energy sensor separated by a slot or air gap. The interruption of this beam causes an on/off signal from the sensor. When the energy path is blocked, the sensor will be "off" allowing only leakage current to flow. When the energy path is open, the sensor will be "on," causing significantly higher currents to flow. This is often accomplished by placing a rotating plate (or encoder disc) in the slot between the LED and energy sensor as shown in Figure 1.

Figure 1 - Tachometer or Motor Speed Monitor

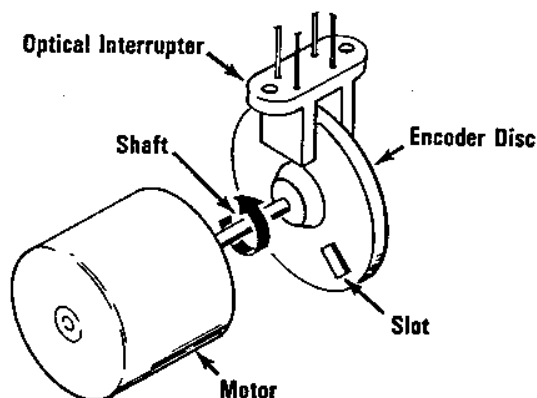

There is usually an opening or slot in the encoder disc that allows the photosensor to be exposed to energy from the LED once each revolution. The energy through the slot will cause the sensor to turn "on" when the slot is present and turn "off" after the slot goes by. This energy pulse will relate the mechanical motion of the encoder disc to the electrical signal by giving one pulse per revolution. By counting these pulses for a given time interval, the speed of rotation may be determined. This gives rise to the "Tachometer" or motor speed monitor.

This encoder disc may be replaced with a fence or comb that passes through the same slot. The same logic presented for the encoder disc will hold true. One electrical pulse is formed for each opening in the fence or comb that passes the LED/sensor pair. Thus the linear motion of the fence or comb can be related to an electrical series of pulses. Figure 2 shows this mechanical system pictorially.

Figure 2 - Linear Encoder Relating Distance Versus Pulses

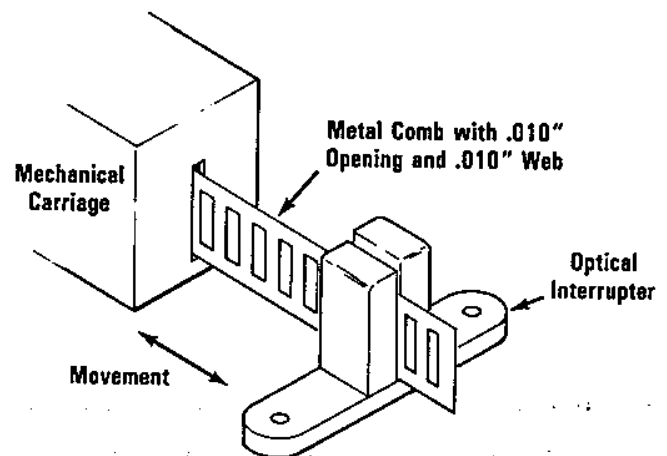

Analysis of the use of an optical interrupter module for a specific application requires several considerations to be analyzed. Most design engineers consider cost, functionality, and reliability as goals in their design. Most important, however, is total application performance. The part must be designed so that minimum support is required in a production type environment. This production environment begins with the fabrication of the basic design and continues through the design performance in subsequent sub-assemblies until the final product is complete. The design is considered successful if, once implementation is complete, the system runs so smoothly, the designer receives no negative feedback. This requires "luck" or a systematic approach to understanding and consideration of all major variables. This application bulletin will use a tachometer design as the mechanism to apply the philosophy of "the successful designer approach."

### Non-apertured Encoding

Most tachometer applications require a digital signal which can be easily processed to determine the speed at which a mechanical motion is taking place. There are several variables that need to be discussed that control this digital signal. Figure 3 pictorially represents the general wave shape that will appear across the load resistor as the slot goes by the sensor.

Figure 3 - Pictorial Representation of Signal Pulse

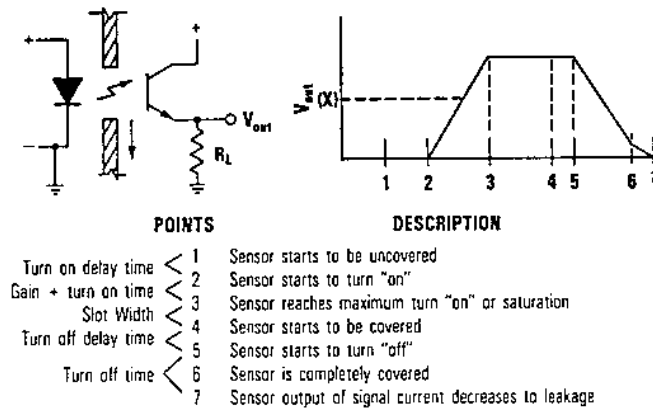

As the slot starts to open up the energy path between the sensor and the LED, the sensor will start to turn "on." If the system has adequate gain, the sensor will saturate prior to the trailing edge of the slot reaching the leading edge of the sensor. The signal level will diminish as the slot goes by reducing the energy level to the sensor.

This time interval from 1 through 7 will remain fairly consistent for a given setup. As different units from various production runs are substituted, the main variations that will be viewed are:

- a. Variations in slope between 2 and 3
- b. Variations in slope between 5 and 7

As the system gain increases, the turn on time will decrease and the flat portion between 3 and 5 will get wider. In other words, 3 will move to the left and 5 will move to the right. The turn on delay will decrease slightly, moving 2 to the left. The point labeled 7 will move to the right showing the sensor turn off time has increased. This will cause the voltage reading at point 6 to increase. As the system gain decreases, the inverse will happen. Points 3, 4, and 5 will become one point and start to decrease. Points 1 and 6 never move. If the circuit is desired to turn on or off at level "X," the "X" will move as these slopes change.

The OPB860T55 is a commercially available optical interrupter from Optek Technology. It has no built-in aperture. It will be used as an example for the discussion of the choice of a specified load resistor. Figure 4 shows a typical circuit where  $V_{out}$  will drive the input of a TTL gate such as the SN7414 Schmitt trigger.

Figure 4 - Optical Beam Interrupter

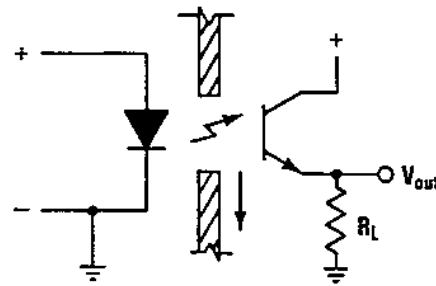

The choice of this load resistor is usually the first parameter the design engineer must consider. The end result is a TTL compatible analog voltage generated across this load resistor. The minimum allowed on-state current and the maximum allowed off-state current of the OPB860T55 become the first two restrictions on the choice of this load resistor. In order to be able to generate a reliable digital output, the system must guarantee the analog voltage will swing above and below the positive and negative going thresholds, respectively, of the TTL gate. Figure 5 shows the output of the OPB860T55 with the resistive load of 1000 ohms, and 10,000 ohms.

Figure 5 - OPB860T55 Output Versus  $R_L$

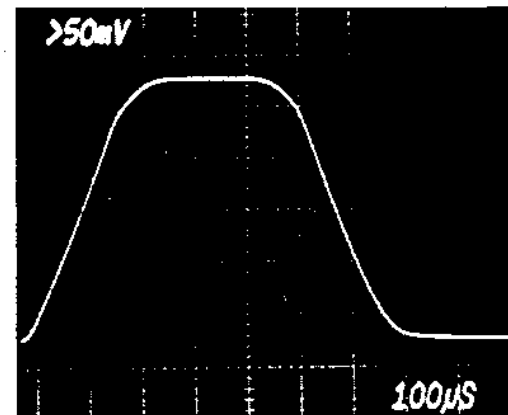

$R_L = 1000 \text{ ohms}$

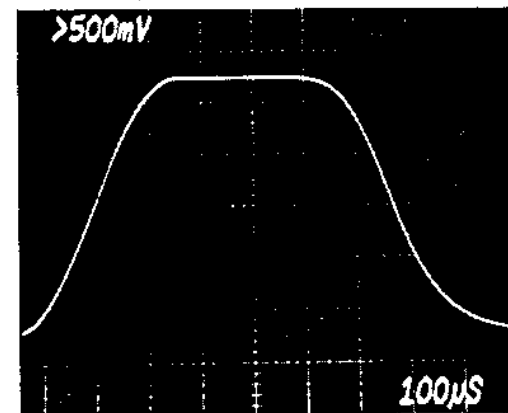

$R_L = 10,000 \text{ ohms}$

A study of these photographs will quickly show a positive and a negative aspect. As you increase the value of the load resistor, the analog voltage swing across it quickly increases. The standard product guarantees 500 microamperes of output with a 20-milliampere input. This corresponds to 500 millivolts across 1000 ohms and 5 volts across 10,000 ohms. The maximum turn on voltage required to trip the SN7414 is 2.0 volts. It also becomes apparent that as you increase the value of the load resistance, the rise and fall time is adversely affected. The rise time (10% to 90%) is 160 microseconds with the 1000-ohm load increasing to 180 microseconds with the 10,000-ohm load. The fall time (90% to 10%) is 170 microseconds with the 1000-ohm load increasing to 200 microseconds with the 10,000-ohm load. The frequency response is significantly decreased with increased load resistance. Keep in mind that the measured rise times and fall times are a combination of the electrical rise and fall time of the sensor as well as the mechanical rise and fall time of the system. The sensor gradually is exposed to the light as it is uncovered and the light is gradually removed as it is covered. This increase in load resistance may lead to a secondary problem.

As the magnitude of the load resistor is increased, greater care must be taken in the mechanical design to prevent off-state problems. This means guarding against spurious light signals that may create noise or unwanted signal levels adequate to give a signal pulse when none is there.

Two other options become potential problem solvers. Increasing the LED drive current will increase the output current. Care must be taken as increasing the drive current will also decrease reliability. The supplier may be asked to select units that will give a higher output. This will increase the cost in inverse proportion to the amount of units meeting the new requirements that lie within the production distribution.

### Apertured Encoding

The OPB860 series are available with sensor apertures of .010" and .050". The OPB860T51 which has a .010" x .040" sensor aperture will be discussed. It offers a good alternative to the OPB860T55 when resolution becomes more critical. Figure 6 shows the comparison of the wave shapes across the 1000-ohm  $R_L$  of the OPB860T55 and OPB860T51.

The waveforms shown in Figure 6 are made with an apertured disc that had .025" openings and .038" opaque areas for its total periphery. This causes the OPB860T55 (top trace) not to go completely to ground potential which is the cross hatched "x" line on the scope faceplate. This is due to the "light bleed" around the .038" opaque area causing the sensor to continue conduction. This would not be present in single pulses per revolution. Minimization of the "light bleeding" can be obtained by making the encoder disc (50% opaque-50% open) 25% larger than the width of the sensor aperture. The turn on and turn off times are about 60 microseconds for the OPB860T51 and 80 microseconds for the OPB860T55. This is due to the mechanical turn on and turn off

Figure 6 - OPB860T55 (upper) Versus OPB860T51 (lower)

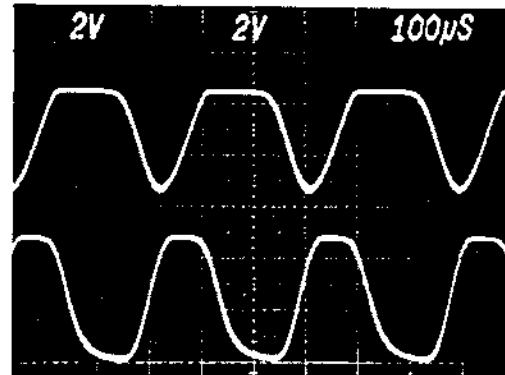

times being limited to .010" in the OPB860T51 while going as long as .060" on the OPB860T55.

In addition, it is important to keep the encoder disc as close to the sensor as possible to further decrease "light bleeding." Note that the output level of the sensor in an individual unit will decrease as the encoder wheel moves laterally from the LED or emitter side toward the sensor side of the unit. This is shown in Figure 7.

Figure 7 - Normalized Sensor Output Versus Lateral Slot Opening

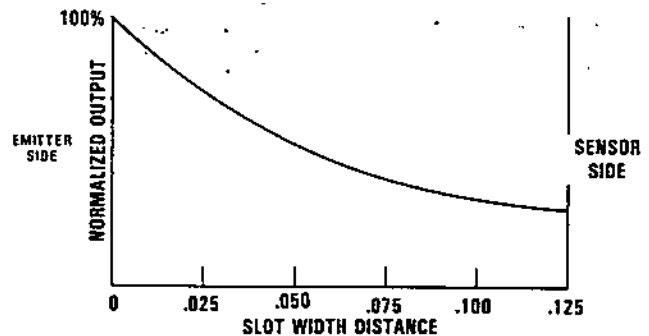

This is brought about because the energy from the LED is not collimated and does not have a point source radiation pattern. In addition to the encoder position relative to the sensor, the effect can be minimized by minimizing wobble of the encoder wheel within the interrupter slot. In more complex applications where much greater resolution is needed, i.e., the width of the LED and sensor apertures are decreased to the point that energy from the LED cannot be detected by the sensor, the use of a multi-slotted aperture called a reticle with a pattern identical to the encoder disk is used. (See Application Bulletin 206 for more information.) The effect is a shuttering of light. It allows more energy to be sensed by the sensor while maintaining high resolution.

Another solution to the higher resolution requirements is to use Photologic™. This improves timing accuracy when it is not convenient to have amplification circuitry in close physical proximity

to the optical interrupter module. This amplification guards against noise causing spurious signals which could upset system performance.

### Apertured Function Encoding

The solution to the problems presented before is a sensor function. The OPB960T51 is similar in appearance to the OPB860T51. It requires three leads for the sensor rather than two leads. The sensor function is a Photologic™ chip consisting of a photo sensitive element and a Schmitt trigger buffer integrated on a common chip. The housing contains a .010" aperture in front of the Photologic™ sensor to allow for high resolution encoding. The frequency response of the OPB960T51 is improved over the OPB860T51 to 250 kHz with typical rise and fall times of 70 nanoseconds. The output is capable of driving 8 TTL loads over the temperature range of -40 °C to +70 °C. Figure 8 clearly shows the suitability of the OPB960T51 when compared to the OPB860T51.

Figure 8

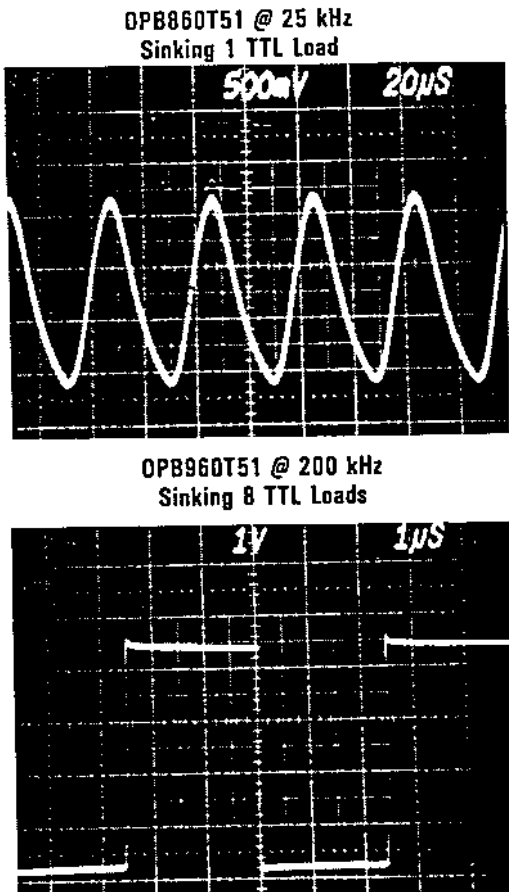

As long as the required frequency response is slow enough and the output is adequate, the OPB860T51 is the best choice from a system cost. This is further supported if unused logic gates exist for the designer to process the opto signal into a digital output. As the applications become more sophisticated and importance is shifted to improved performance and simplification of complex processing circuits, the OPB960T51 becomes the best choice for the designer. A major advantage to the designer is the guaranteed performance from -40 °C to +70 °C. The result is a much more reliable design in terms of degradation and system performance.

### Conclusion

The OPB860T55 (non-apertured optical interrupter) will perform quite reliably in low speed, low resolution encoding. The OPB860 family offers an improvement in resolution. The narrow aperture offers superior resolution in linear encoders. The OPB960T51 is the choice where higher output levels, speed, and precise resolution are required.

Refer to Application Bulletins 203 and 206 for additional information.

THOMAS W. SWARD

WILLIAM NUNLEY